

Blast Valve with Prefilter

Type ESVF 2403 X

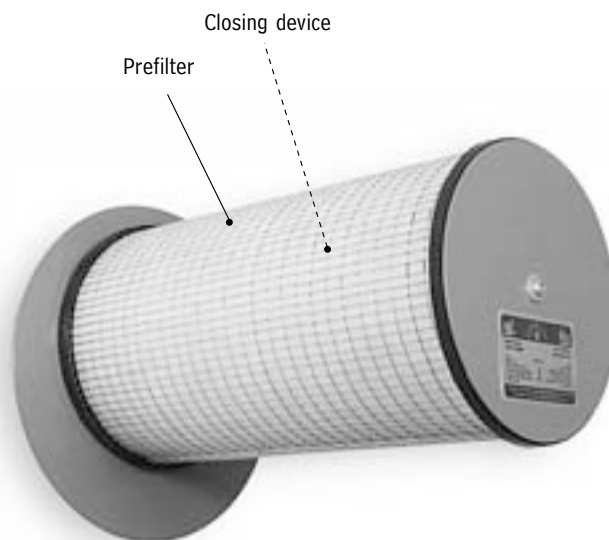

Overview

The Blast Valve with Prefilter Type **ESVF 2403 X** is a heavy duty valve which protects the interior of a shelter from blast waves caused by outside explosions. A prefilter with an efficiency of 85% is fully integrated. The valve is normally open. If the air flow rate exceeds the nominal value by approx. 80%, the valve will close instantly. It can withstand blast waves of 3 bar (42 psi) (infalling pressure). The valve is tested and certified to the Israeli Standard 4570 by the Civil Defence Command and the Standards Institution of Israel.

Description

The Blast Valve with Prefilter Type **ESVF 2403 X** is a valve against explosive and implosive waves. It is maintenance-free, temperature and corrosion resistant. The springs are manufactured from special stainless steel and all steel parts are phosphate treated and finished with a powder coating.

Usage

- Has to be installed at the air intake inside the shelter in a vertical position to ensure proper operation
- Has to be installed on an 8" flange according to BS 4504 - PN 6 or DIN 2501 - PN 6
- Should only be installed together with "Noah's Ark" equipment manufactured by Beth-El Industries to ensure maximum performance



Beth-El Zikhron Yaaqov Industries Ltd.
 1 Avshalom Road, P.O. Box 166
 Zikhron Yaaqov 30951, Israel
 Tel.: +972-4-629 9999
 Fax: +972-4-629 1110

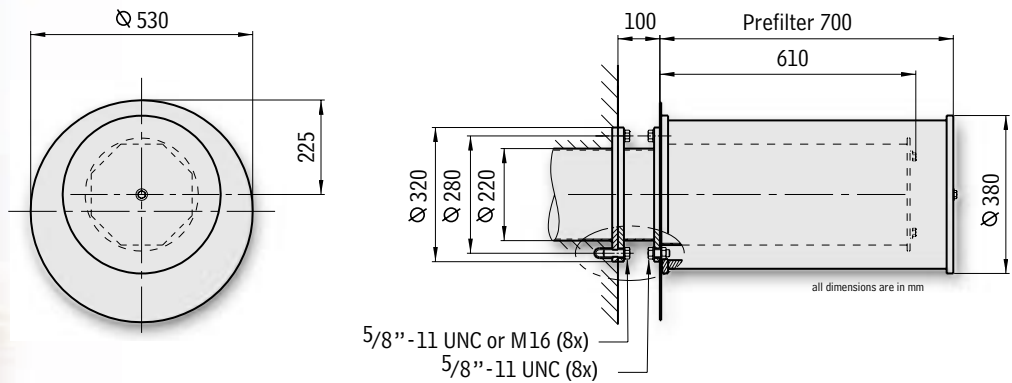
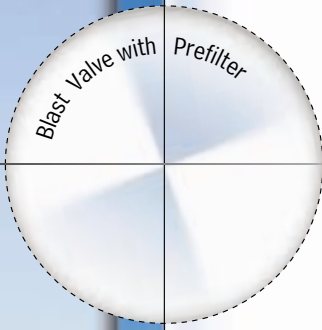

Certifications:

- Tested and certified to IS 4570 by the Standards Institution of Israel
- Approved by the Civil Defence Command of Israel
- Quality Control according to ISO 9001
- Quality Assurance AQAP 120

Pressure Drop on Airflow ESVF 2403 X (without protection housing):

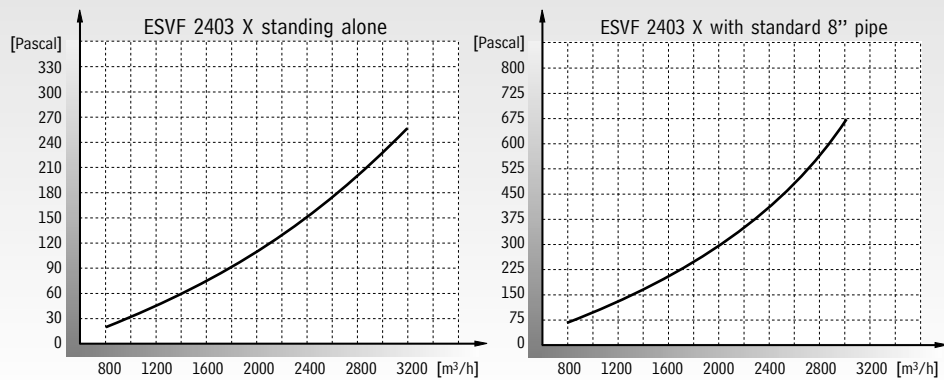

Specifications ESVF 2403 X (without protection housing):

Airflow rate:	up to 3000 (1770)	m³/h (cfm)
Flow resistance:	see diagram	
Incident pressure durability:	300 (42)	kPa (psi)
Reflected pressure durability:	1100 (154)	kPa (psi)
Working temperature:	+5 to +70 (+40 to +160)	°C (°F)
Mechanical shock resistance:	20	g

Specifications are subject to change without prior notice

